

DURACELL[®]

PLUS

MEGA-PILES

MN1400

Size: C (LR14)

Alkaline-Manganese Dioxide Battery

Zn/MnO₂

<https://www.mega-piles.com/>

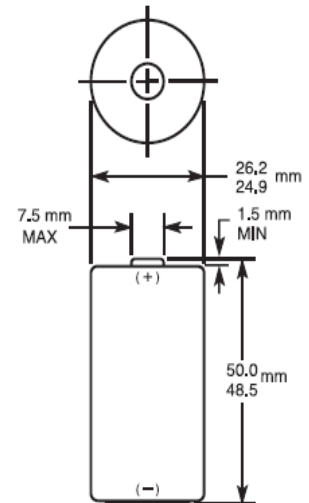

Dimensions shown are IEC standards

| | |
|------------------------------------|---|
| Nominal voltage | 1.5 V |
| Impedance | 130 m-ohm @ 1 kHz |
| Typical weight | 71 g (2.4 oz) |
| Typical volume | 26.9 cm ³ (1.6 in ³) |
| Terminals | Flat |
| Storage temperature range | 5°C to 30°C (41°F to 86°F) |
| Operating temperature range | -20°C to 54°C (-4°F to 130°F) |
| Designation | ANSI: 14A IEC: LR14 |

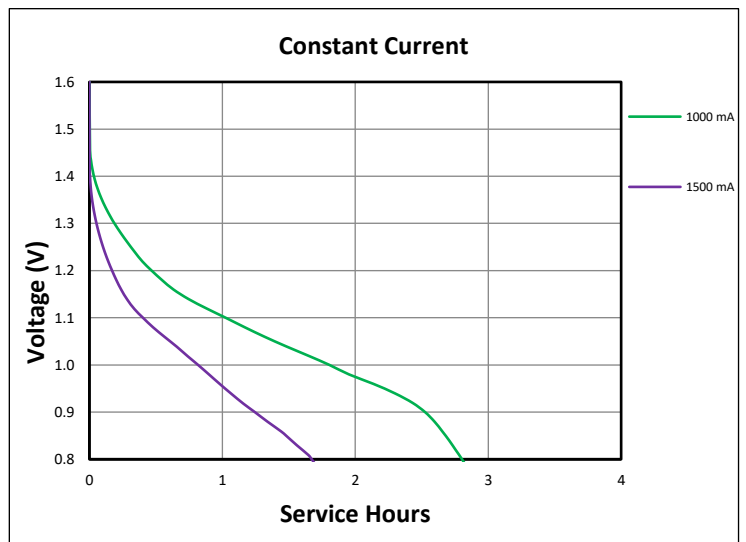
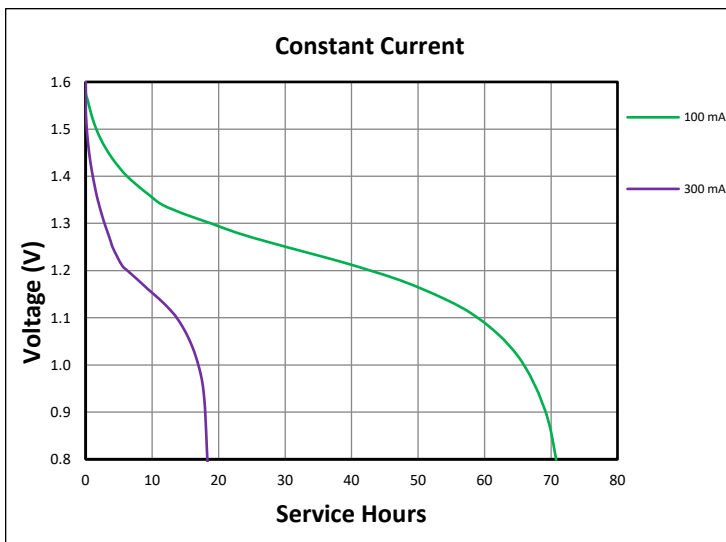

DURACELL[®]

BATTERIES

Berkshire Corporate Park
Bethel, CT. 06801 U.S.A.
Telephone: Toll-free 1-800-544-5454
www.duracell.com

Delivered capacity is dependent on the applied load, operating temperature and cut-off voltage. Please refer to the charts and discharge data shown for examples of the energy/service life that the battery will provide for various load conditions.

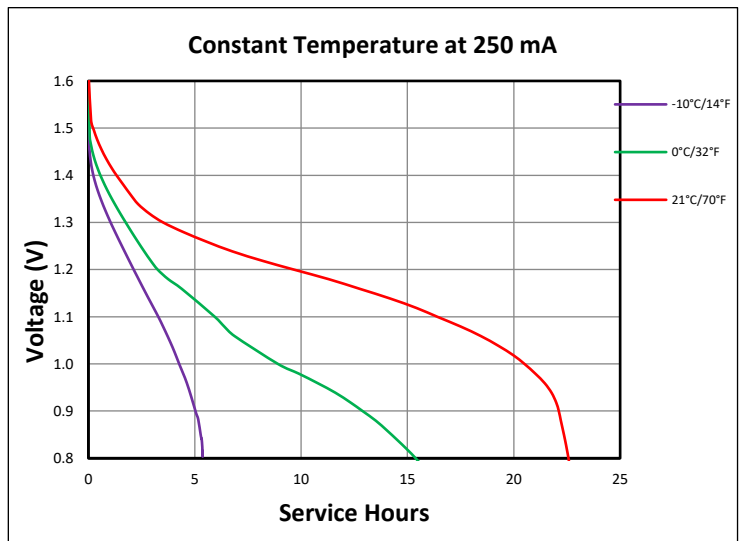
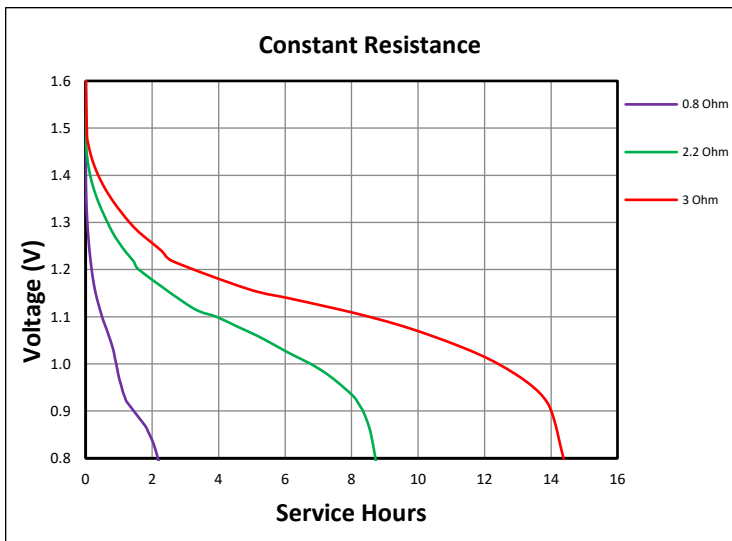
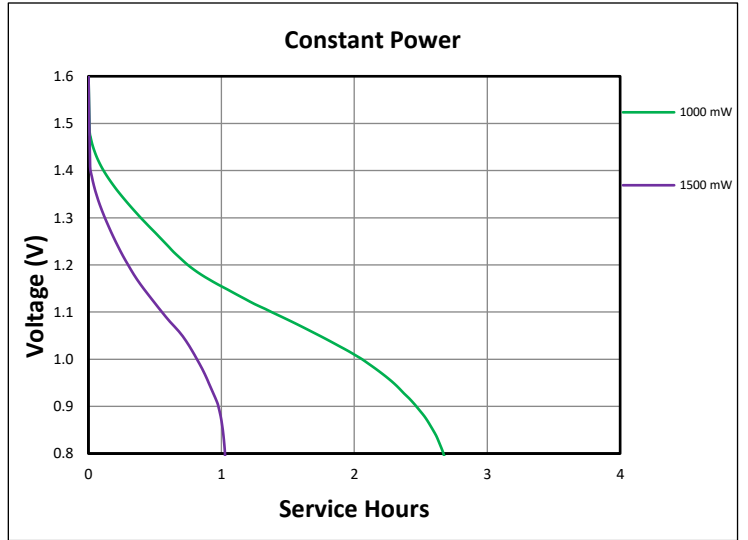
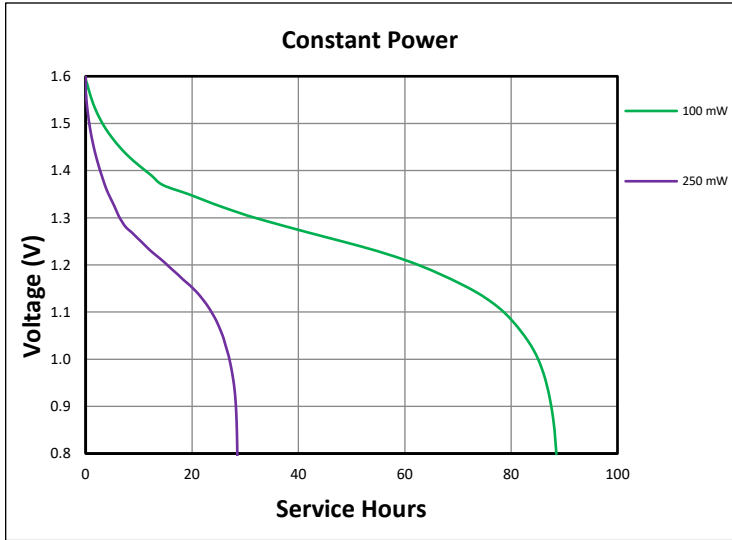

DURACELL[®]

BATTERIES

Berkshire Corporate Park
Bethel, CT. 06801 U.S.A.
Telephone: Toll-free 1-800-544-5454
www.duracell.com

Delivered capacity is dependent on the applied load, operating temperature and cut-off voltage. Please refer to the charts and discharge data shown for examples of the energy/service life that the battery will provide for various load conditions.