

ENERGIZER 391/381

SILVER OXIDE

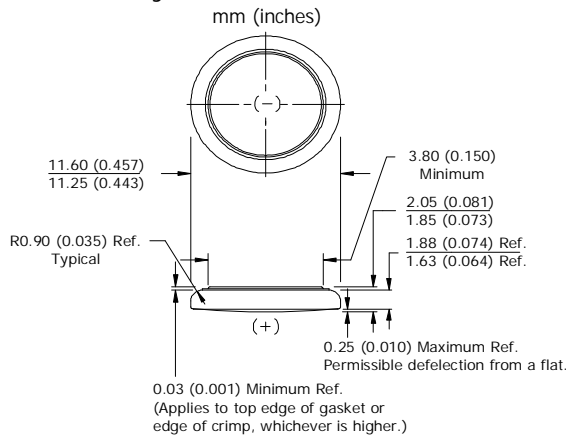

Industry Standard Dimensions



DESIGNED FOR USE ON CONTINUOUS LOW DRAIN
HIGH PULSE ON DEMAND

Specifications

Chemical System:	Silver Oxide (Zn/Ag ₂ O)
Designation:	IEC-SR55
Nominal Voltage:	1.55 Volts
Typical Capacity:	47 mAh* (to 1.2 volts)
Capacity Test:	15K ohm continuous drain at 21°C
Typical Weight:	0.93 grams
Typical Volume:	0.22 cubic centimeters
Impedance (40 Hz):	5 to 7 ohms

* Varies according to the applied load, temperature, and cutoff voltage.

Cross Section

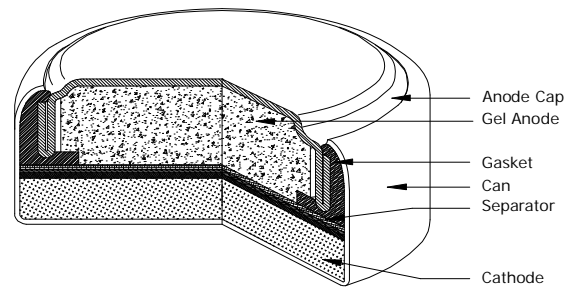

Typical Discharge Characteristics

Typical Performance at 21°C (70°F)

Schedule: Continuous
Typical Drain @ 1.55V:
0.103 milliamperes
Load: 15K ohm

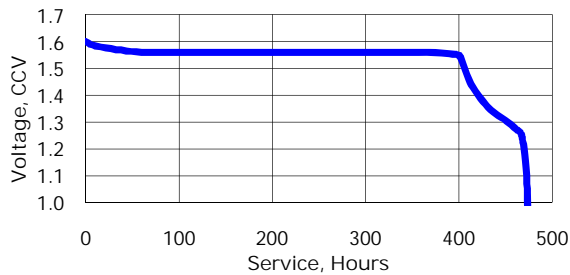

Schedule	Typical Drains at 1.55V (milliamperes)	Load (ohm)	Cutoff (hours)
Continuous	0.103	15K	456

Temperature Characteristics

Typical Performance at Low Discharge Rates

Service Effects

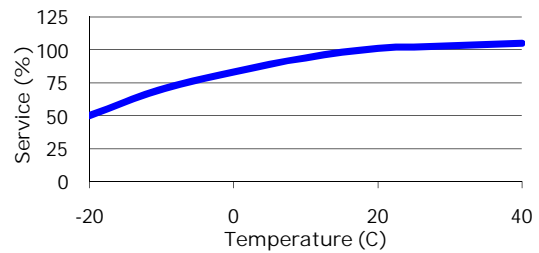

Storage Effects

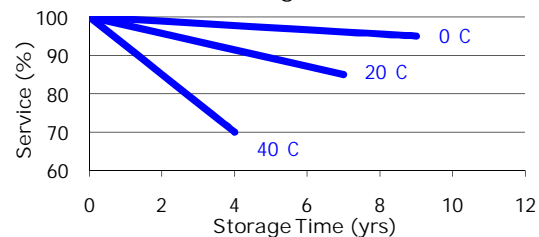

Important Notice

This datasheet contains typical information specific to products manufactured at the time of its publication.
©Energizer Holdings, Inc. - Contents herein do not constitute a warranty.